

# Data Sheet



Article number: 021500700083

Description: Sealing Clamp S 73 W5

## Measures

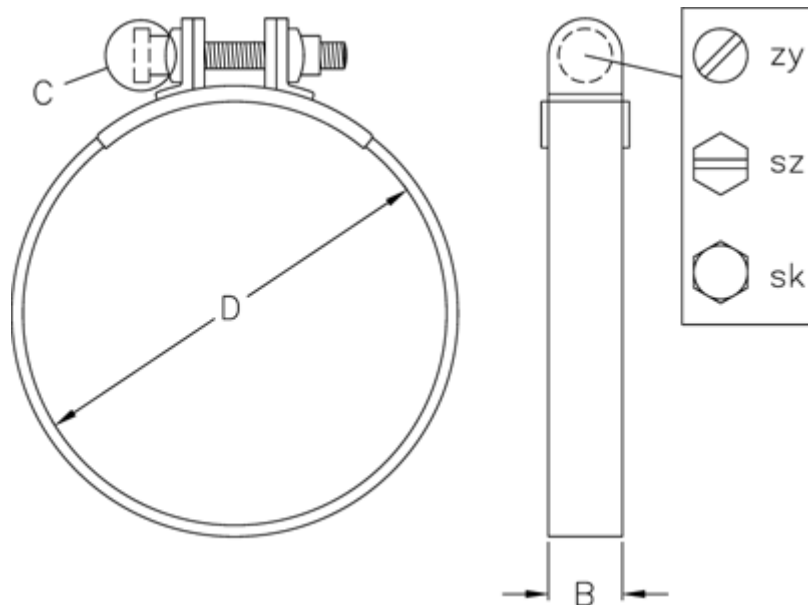

C (screw type) = SZ

Diameter D = 83

Width B = 20